

SPACERS, EXPANSION JOINTS AND PROFILES



REMOVABLE AND REUSABLE DUAL SIZE (JOINT)

SPACER

DOUBLE R2

SPACERS FOR 20 mm THICKNESS TILES

SPACERS FOR 20 mm THICKNESS TILES R3

3 IN-ONE TILE SHIM "ROTOCUNEO"

"ROTOCUNEO" FOR JOINTS FROM 2 mm UP TO 10 mm.....R3

SPACERS FOR "+" AND "T" SETTING LAYOUT

10 mm R4

9 mm R4

8 mm R4

7 mm R4

6 mm R5

5 mm R5

4 mm R5

3 mm R6

2 mm R6

1,5 mm R6

1 mm R6

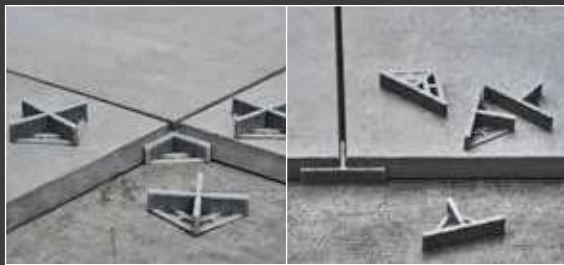

SPACERS FOR OCTAGONAL TILES, "CASSETTONATO"

AND LOZENGE, SPACERS FOR HEXAGONAL TILES,

SPACERS FOR PROVINCIAL - "PROVENZALE"

SPACERS FOR OCTAGONAL TILES, "CASSETTONATO"

AND LOZENGE R7

SPACERS FOR HEXAGONAL TILES R7

SPACERS FOR PROVINCIAL - "PROVENZALE" R7

SPACERS FOR SPECIAL FORMATS (RHOMBUS) R7



WEDGES

BIG WEDGES R7

SMALL WEDGES R7

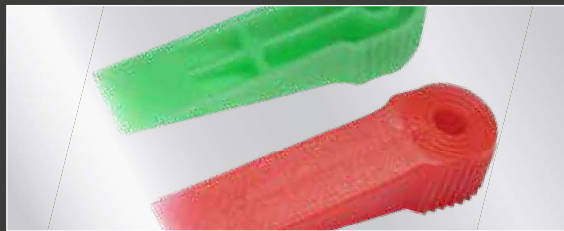

FLOATING FLOORS SUPPORTS

FLOATING FLOORS SUPPORTS R7

EXPANSION JOINTS AND PROFILES

EXPANSION JOINTS R8

PVC TRANSITION PROFILES R8

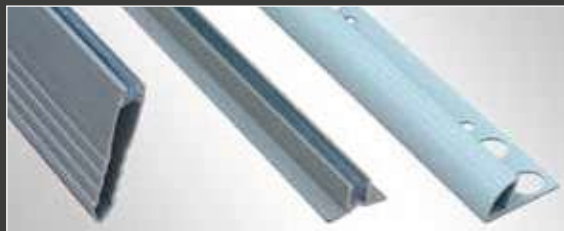

11 sizes (from 1 to 10 mm - 1/32" - 3/8") in 43 different models : here is our range of spacers. A line of spacers for the professional which can choose versions with different heights, with holes for the passage of the adhesive, with fins for easy removal or to avoid the outcrop if installing with the traditional "mud-med" method, or even with the unique "Lego" system, which allows to fit a spacer over the other to get the desired thickness. Of course, both for cross and "T" installation. In addition, three models (3 mm - 1/8" joint) for octagonal tile, "cassettonato", lozenge, hexagonal tiles, "provenzale" tiles and two models (2 mm - 3/32" joint) for special formats (rhombus). To complete the offer, shimming wedges are available in two sizes and "Rotocuneo", the new 3-in-one tile shim for adjustments from 2 mm (3/32") up to 10 mm (3/8"). Also expansion joints, profiles and floating floors supports and the new spacers designed for the laying of tiles with high thickness (20 mm - 3/4"), whose characteristics make them ideal for outdoor floors. Last, but not least, the removable and reusable dual size (joint) spacer "DOUBLE", available in two versions, each one designed to create two joints of different sizes (one model for joints of 1 and 3 mm - 1/32" and 1/8", one model for joints 2 and 5 mm - 3/32" and 3/16"). Designed to work on the sides of the tiles and flush to the floor as well as into corners. This is particularly helpful for wall covering.

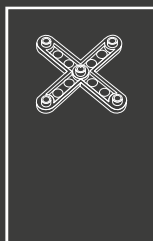

REMOVABLE AND REUSABLE DUAL SIZE (JOINT) SPACER

MADE IN ITALY



282D1-3C300
Rear view (flat facet)



282D1-3C300
Front view



1 mm | 1/32"

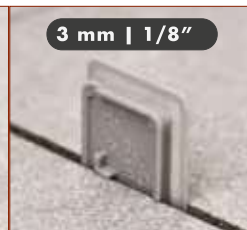

3 mm | 1/8"



282D2-5C300
Rear view (flat facet)



282D2-5C300
Front view



2 mm | 3/32"



5 mm | 3/16"

- Available in two versions: to create joint sized 1 and 3 mm - 1/32" and 1/8" (grey color); to create joints sized 2 and 5 mm - 3/32" and 3/16" (red color).
- Each DOUBLE is designed to create two joints of different sizes: two sides for one joint size, the other two for the other joint size. Therefore, DOUBLE is actually a "Dual-Size" removable (and reusable) spacer.
- The dual size (joint) spacer DOUBLE has been de-signed to be very easy to remove after use. This in accordance with regulations about correct ceramic tile installation such as the Italian UNI 11493-1.
- The removal and use do not damage the product therefore DOUBLE is reusable virtually forever.
- Its generous dimensions (37x37 mm | 1 1/2"x1 1/2") make very easy to grasp it both during insertion and, even more important, removal phase.
- The wide gap within joints sizes present on the same spacer makes it easy to recognize them.

- Thanks to the wide contact surface between tiles once in working position, DOUBLE ensures both perfect joint size and parallelism of the tiles.
- DOUBLE is designed to work on the sides of the tiles (not into intersections) so to ensure the maximum effectiveness (especially on large format tiles).
- One of the two facets of DOUBLE is flat so to allow the product to be used flush to the floor as well as into corners. This is particularly helpful for wall covering.
- DOUBLE is made of plastic material which hinders the adhesion of the adhesive (thin-set) to the spacer.
- Double is proposed inside a practical resealable bucket for storing the product after use.

DOUBLE 1-3 mm (1/32" - 1/8") and 2-5 mm (3/32" - 3/16")

Part No.			Description	Joint	Color		
282D1-3C300	8050532000636	6	DOUBLE SPACER; joint 1 and 3 mm (1/32" - 1/8"). 300 pcs bucket.	1 and 3 mm 1/32" and 1/8"		58x20xh 27 cm 23"x8"x h 10 1/2"	5,5 Kg 12.1 lbs
282D2-5C300	8050532002432	6	DOUBLE SPACER; joint 2 and 5 mm (3/32" - 3/16"). 300 pcs bucket.	2 and 5 mm 3/32" and 3/16"			6,9 Kg 15.2 lbs

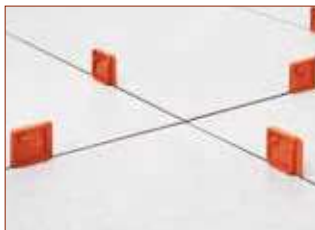

SPACERS FOR 20 mm (3/4") THICKNESS TILES – JOINT 4 mm (5/32")

MADE IN ITALY

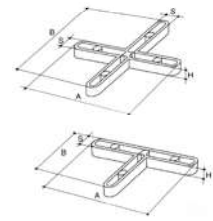
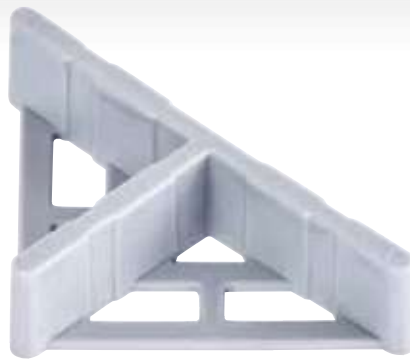
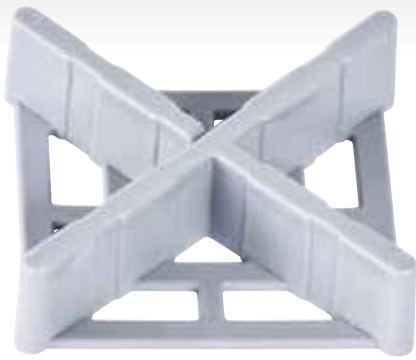

313+200		313+500	
S	A	B	H
4mm 5/32"	64mm 2 1/2"	64mm 2 1/2"	12mm 15/32"

313T200		313T500	
S	A	B	H
4mm 5/32"	64mm 2 1/2"	34mm 1 11/32"	12mm 15/32"

- Spacers for tiles/slabs with a thickness equal or higher than 20 mm (3/4").
- Available both "+" and "T" types.
- Perfect for outdoor floors laid both with adhesive or onto sand.
- Made of plastic material which is tested for being resistant even when subjected to bad weather conditions and thermal stress.

- Equipped with special wings, designed for preventing the rising of the spacer during the vibrator method.
- The special wings are also provided with specific openings with draining function.
- Spacer's height: 12 mm (1/2").

Part No.	Barcode	Type	Pieces	Box	Bag	Arch	Round	Down	Up	Box	Weight	Weight	
313+200	8024648095268	+	200	-	•	-	•	-	•	•	8	9,7 Kg	21.4 lbs
313+500	8024648095275	+	500	-	•	-	•	-	•	•	3	9,2 Kg	20.3 lbs
313T200	8024648095282	T	200	-	•	-	•	-	•	•	12	11 Kg	24.3 lbs
313T500	8024648095299	T	500	-	•	-	•	-	•	•	5	11,4 Kg	25.1 lbs

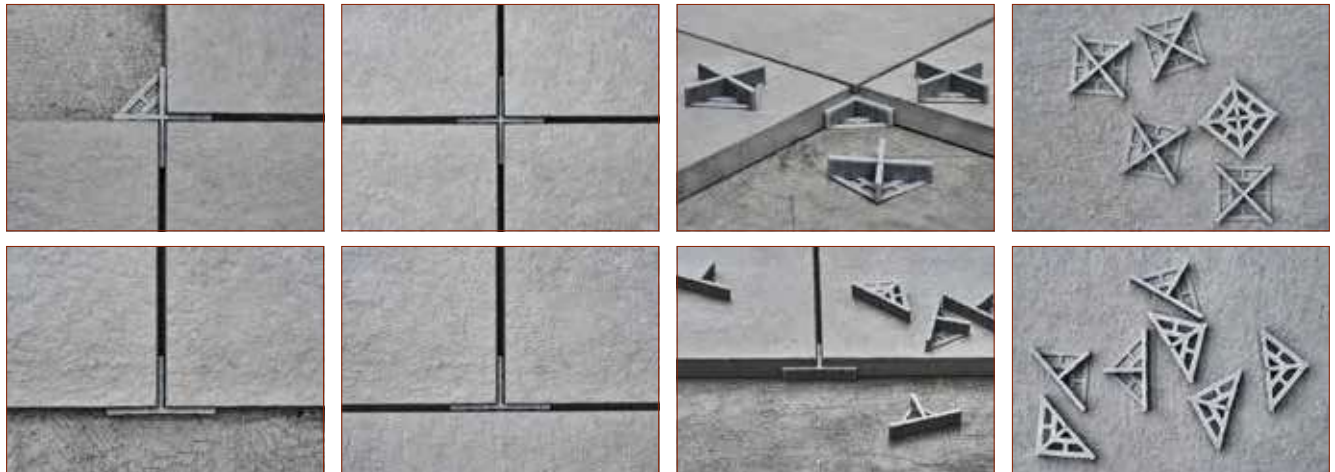

ROTOCUNEO - FROM 2 mm (5/64") UP TO 10 mm (3/8") JOINTS

MADE IN E.U.



- 3 in 1 tile shim: 2 spiral-shaped wedges (lateral ones) + 1 wedge (middle one).
- For joint adjustments from 2 to 10 mm.

- In the removal phase, it avoids the chipping of the tile / slab.
- Recommended for extremely delicate tiles / slabs.

Part No.	Barcode	Box	Description	Joint	Weight	Weight	Box	Weight	Weight	
162RC30	8050532006775	27	30 Kits RotocunEO bucket (60 spiral-shaped wedges + 30 wedges)	from 2 to 10 mm from 3/32" to 3/8"	220 gr	0.5 oz	40x60xh 25 cm	15 3/4"x23 5/8"xh 10"	7 Kg	15.4 oz

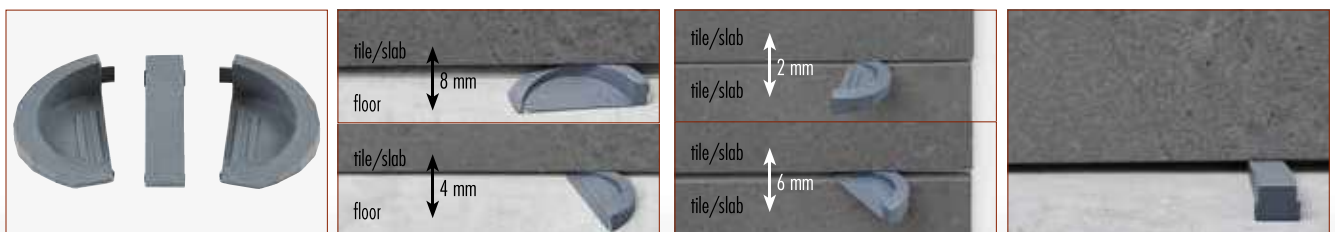

SPACERS 10 mm – 3/8"

MADE IN ITALY



204+200			
S	A	B	H
10mm	40mm	40mm	7mm
3/8"	1 9/16"	1 9/16"	9/32"



204 R200			
S	A	B	H
10mm	50mm	50mm	13mm
3/8"	2"	2"	17/32"



204T200			
S	A	B	H
10mm	40mm	25mm	7mm
3/8"	1 9/16"	1"	9/32"



204T200A			
S	A	B	H
10mm	50mm	30mm	13mm
3/8"	2"	1 3/16"	17/32"

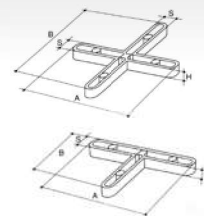

Part No.	Barcode	Type	Pieces	Box	Bag	Upright	Arch	Down	Black	Up	Box	Box	Weight	
204+200	8024648001641	+	200	-	•	•	-	-	•	-	25	48x46x28 cm	18 7/8"x18 1/8"xh 11"	10,6 Kg 23.3 lbs
204R200	8024648001634	+	200	-	•	•	-	•	-	•	10	48x46x28 cm	18 7/8"x18 1/8"xh 11"	9,2 Kg 20.3 lbs
204T200	8024648001658	+	200	-	•	•	-	•	-	-	25	48x35x28 cm	18 7/8"x13 3/4"xh 11"	7,4 Kg 16.3 lbs
204T200A	8024648001665	+	200	-	•	•	-	•	-	-	10	48x35x28 cm	18 7/8"x13 3/4"xh 11"	6,6 Kg 14.5 lbs

SPACERS 9 mm – 11/32"



128+200			
S	A	B	H
9mm	50mm	50mm	7mm
11/32"	2"	2"	9/32"



128T200			
S	A	B	H
9mm	50mm	30mm	7mm
11/32"	2"	1 3/16"	9/32"

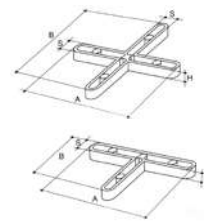

Part No.	Barcode	Type	Pieces	Box	Bag	Upright	Arch	Down	Black	Up	Box	Box	Weight	
128+200	8024648001672	+	200	-	•	•	-	•	-	-	25	48x46x28 cm	18 7/8"x18 1/8"xh 11"	13,6 Kg 29.9 lbs
128T200	8024648001689	+	200	-	•	•	-	•	-	-	25	48x35x28 cm	18 7/8"x13 3/4"xh 11"	10,6 Kg 23.3 lbs

SPACERS 8 mm – 5/16"



376+200			
S	A	B	H
8mm	40mm	40mm	7mm
5/16"	1 9/16"	1 9/16"	9/32"



376T200			
S	A	B	H
8mm	40mm	25mm	7mm
5/16"	1 9/16"	1"	9/32"

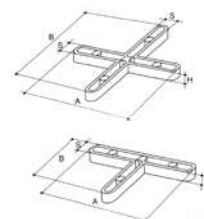

Part No.	Barcode	Type	Pieces	Box	Bag	Upright	Arch	Down	Black	Up	Box	Box	Weight	
376+200	8024648001696	+	200	-	•	•	-	•	-	-	25	48x46x28 cm	18 7/8"x18 1/8"xh 11"	9,6 Kg 21.2 lbs
376T200	8024648001702	+	200	-	•	•	-	•	-	-	25	48x35x28 cm	18 7/8"x13 3/4"xh 11"	7,6 Kg 16.7 lbs

SPACERS 7 mm – 9/32"



152+1000E		151+200E	
S	A	B	H
7mm	40mm	40mm	7mm
9/32"	1 9/16"	1 9/16"	9/32"



151+200L			
S	A	B	H
7mm	40mm	40mm	5mm
9/32"	1 9/16"	1 9/16"	3/16"



152T1000E		151T200E	
S	A	B	H
7mm	40mm	25mm	7mm
9/32"	1 9/16"	1"	9/32"

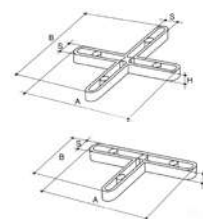

Part No.	Barcode	Type	Pieces	Box	Bag	Upright	Arch	Down	Black	Up	Box	Box	Weight	
152+1000E	8024648001375	+	1000	•	-	•	-	-	•	-	12	62x42x54 cm	24 3/8"x16 1/2"xh 21 1/4"	26 Kg 57.3 lbs
151+200E	8024648001719	+	200	-	•	•	-	•	-	-	25	48x46x28 cm	18 7/8"x18 1/8"xh 11"	10,6 Kg 23.4 lbs
151+200L	8024648001726	+	200	-	•	•	-	•	-	-	25	48x35x28 cm	18 7/8"x13 3/4"xh 11"	5,6 Kg 12.3 lbs
152T1000E	8024648001399	+	1000	•	-	•	-	-	•	-	8	46x41x32 cm	18 1/8"x16 1/8"xh 12 5/8"	13,3 Kg 29.3 lbs
151T200E	8024648001733	+	200	-	•	•	-	•	-	-	30	48x35x28 cm	18 7/8"x13 3/4"xh 11"	9,6 Kg 21.2 lbs



SPACERS 6 mm – 1/4"

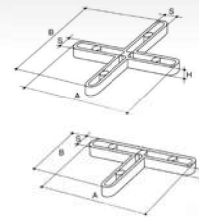
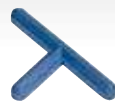

MADE IN ITALY

153+200

S	A	B	H
6mm	50mm	50mm	7mm
1/4"	2"	2"	9/32"

153T200

S	A	B	H
6mm	50mm	28mm	7mm
1/4"	2"	1 7/64"	9/32"

Part No.	Barcode	Type	Pieces	Box	Envelope	Upright	Arch	Down Arrow	Up Arrow	Box	Box	Box			
153+200	8024648001740	+	200	-	•	-	•	•	-	-	25	48x46xh 28 cm	18 7/8"x18 1/8"xh 11"	8,13 Kg	17.9 lbs
153T200	8024648001757	T	200	-	•	-	•	•	-	-	30	48x35xh 28 cm	18 7/8"x13 3/4"xh 11"	8,1 Kg	17.8 lbs

SPACERS 5 mm – 3/16"

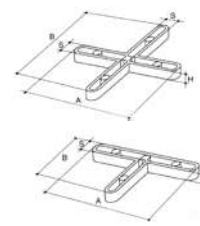

156+1000		155+200	
S	A	B	H
5mm	50mm	50mm	6mm
3/16"	2"	2"	1/4"

156+1000L		155+200L	
S	A	B	H
5mm	40mm	40mm	5mm
3/16"	1 9/16"	1 9/16"	3/16"

155R200			
S	A	B	H
5mm	50mm	50mm	6mm
3/16"	2"	2"	9/32"

156T1000		155T200	
S	A	B	H
5mm	35mm	28mm	6mm
3/16"	1 3/8"	1 7/64"	1/4"

156T1000E		155T200E	
S	A	B	H
5mm	35mm	28mm	6mm
3/16"	1 3/8"	1 7/64"	1/4"

Part No.	Barcode	Type	Pieces	Box	Envelope	Upright	Arch	Down Arrow	Up Arrow	Box	Box	Box			
156+1000	8024648001450	+	1000	•	-	-	•	•	-	-	12	62x42xh 54 cm	24 3/8"x16 1/2"xh 21 1/4"	15 Kg	33 lbs
155+200	8024648001795	+	200	-	•	-	•	•	-	-	25	48x46xh 28 cm	18 7/8"x18 1/8"xh 11"	5,6 Kg	12.4 lbs
156+1000L	8024648001436	+	1000	•	-	•	-	-	•	-	16	62x42xh 45 cm	24 3/8"x16 1/2"xh 17 3/4"	16,8 Kg	37 lbs
155+200L	8024648001771	+	200	-	•	•	-	-	•	-	25	48x35xh 28 cm	18 7/8"x13 3/4"xh 11"	5,6 Kg	12.4 lbs
155R200	8024648001764	T	200	-	•	-	•	•	-	•	20	48x46xh 28 cm	18 7/8"x18 1/8"xh 11"	6,6 Kg	14.5 lbs
156T1000	8024648001467	T	1000	•	-	-	•	•	-	-	8	46x41xh 32 cm	18 1/8"x16 1/8"xh 12 5/8"	8,1 Kg	17.8 lbs
155T200	8024648001801	T	200	-	•	•	-	-	-	-	30	48x35xh 28 cm	18 7/8"x13 3/4"xh 11"	6 Kg	13.2 lbs
156T1000E	8024648001443	T	1000	•	-	•	-	-	•	-	16	46x41xh 32 cm	18 1/8"x16 1/8"xh 12 5/8"	14,1 Kg	31 lbs
155T200E	8024648001788	T	200	-	•	•	-	-	•	-	40	32x32xh 28 cm	12 9/16"x12 9/16"xh 11"	6,8 Kg	15 lbs

SPACERS 4 mm – 5/32"

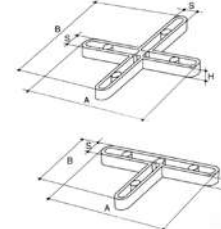

158+1000		157+200	
S	A	B	H
4mm	38mm	38mm	4mm
5/32"	1 31/64"	1 31/64"	5/32"

157R200			
S	A	B	H
4mm	30mm	30mm	6mm
5/32"	1 3/16"	1 3/16"	1/4"

158T1000		157T200	
S	A	B	H
4mm	38mm	20mm	4mm
5/32"	1 31/64"	25/32"	5/32"

Part No.	Barcode	Type	Pieces	Box	Envelope	Upright	Arch	Down Arrow	Up Arrow	Box	Box	Box			
158+1000	8024648001481	+	1000	•	-	•	-	-	•	-	24	62x42xh 45 cm	24 3/8"x16 1/2"xh 17 3/4"	20,7 Kg	45.5 lbs
157+200	8024648001825	+	200	-	•	•	-	-	•	-	50	48x35xh 28 cm	18 7/8"x13 3/4"xh 11"	8,6 Kg	18.9 lbs
157R200	8024648001818	T	200	-	•	-	•	-	•	•	25	32x32xh 28 cm	12 9/16"x12 9/16"xh 11"	6,9 Kg	15.2 lbs
158T1000	8024648001498	T	1000	•	-	•	-	-	•	-	16	46x41xh 32 cm	18 1/8"x16 1/8"xh 12 5/8"	10,1 Kg	22.3 lbs
157T200	8024648001832	T	200	-	•	•	-	-	•	-	40	32x32xh 28 cm	12 9/16"x12 9/16"xh 11"	5,2 Kg	11.5 lbs

SPACERS, EXPANSION JOINTS AND PROFILES





163P1000		162P200	
S	A	B	H
-	28mm 1 7/64"	10mm 13/32"	6mm 1/4"



163G1000		162G200	
S	A	B	H
-	40mm 1 9/16"	9mm 11/32"	8mm 5/16"



MADE IN ITALY

Part No.	Barcode	Type	Pieces	Box	Box	Box	Box	Box	Box	Box	Box	Box	Box	Box	Box
163P1000	8024648001627	▶	1000	•	-	-	•	-	•	-	32	42x42xh40 cm	16 1/2"x16 1/2"xh 15 3/4"	18,2 Kg	40.1 lbs
162P200	8024648001962	▶	200	-	•	-	•	-	•	-	50	32x32xh28 cm	12 9/16"x12 9/16"xh 11"	5,4 Kg	11.9 lbs
163G1000	8024648001610	▶	1000	-	•	-	•	-	•	-	18	62x42xh45 cm	24 3/8"x16 1/2"xh 17 3/4"	20,5 Kg	45.1 lbs
162G200	8024648001955	▶	200	-	•	-	•	-	•	-	25	32x32xh28 cm	12 9/16"x12 9/16"xh 11"	4,2 Kg	9.3 lbs

SPACERS FOR OCTAGONAL TILES, "CASSETTONATO" AND LOZENGE (3 mm - 1/8")



161Y200			
S	A	B	H
3mm 1/8"	22mm 5/7/64"	28mm 1 7/64"	6mm 1/4"

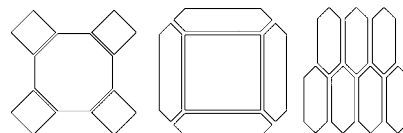
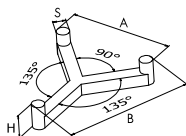

Part No.	Barcode	Type	Pieces	Box	Box	Box	Box	Box	Box	Box	Box	Box	Box	Box	Box
161Y200	8024648001924	Y	200	-	•	-	•	-	•	-	40	32x32xh 28 cm	12 9/16"x12 9/16"xh 11"	3,6 Kg	7.9 lbs

SPACERS FOR HEXAGONAL TILES (3 mm - 1/8")



161E200			
S	A	B	H
3mm 1/8"	34mm 1 11/32"	30mm 1 3/16"	5mm 6/16"

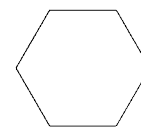
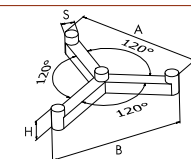

Part No.	Barcode	Type	Pieces	Box	Box	Box	Box	Box	Box	Box	Box	Box	Box	Box	Box
161E200	8024648001931	Y	200	-	•	-	•	-	•	-	40	32x32xh 28 cm	12 9/16"x12 9/16"xh 11"	4,4 Kg	9.7 lbs

SPACERS FOR SPECIAL FORMATS - RHOMBUS - (2 mm - 3/32")



161R200			
S	A	B	H
2mm 3/32"	20mm 25/32"	32mm 1 1/4"	3,5mm 9/64"

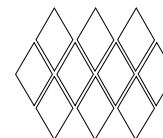
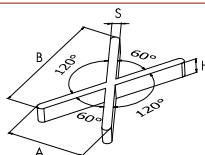

Part No.	Barcode	Type	Pieces	Box	Box	Box	Box	Box	Box	Box	Box	Box	Box	Box	Box
161R200	8050532004184	X	200	-	•	-	•	-	•	-	40	32x32xh 28 cm	12 9/16"x12 9/16"xh 11"	3,7 Kg	8.1 lbs

SPACERS FOR SPECIAL FORMATS - RHOMBUS - (2 mm - 3/32")



161Y200G4			
S	A	B	H
2mm 3/32"	30mm 1 3/16"	34mm 1 1/8"	3,5mm 9/64"

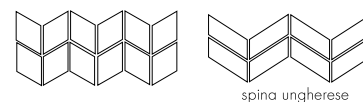
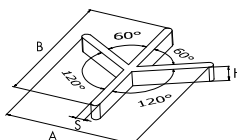

Part No.	Barcode	Type	Pieces	Box	Box	Box	Box	Box	Box	Box	Box	Box	Box	Box	Box
161Y200G4	8050532007093	Y	200	-	•	-	•	-	•	-	40	32x32xh 28 cm	12 9/16"x12 9/16"xh 11"	3,6 Kg	7.9 lbs

SPACERS FOR PROVINCIAL - "PROVENZALE" (3 mm - 1/8")



161P200			
S	A	B	H
3mm 1/8"	-	-	6mm 1/4"



Part No.	Barcode	Type	Pieces	Box	Box	Box	Box	Box	Box	Box	Box	Box	Box	Box	Box
161P200	8024648001948	T	200	-	•	-	•	-	•	-	40	32x32xh 28 cm	12 9/16"x12 9/16"xh 11"	4,4 Kg	9.7 lbs

FLOATING FLOORS SUPPORTS



312P300		
S	O	H
4mm 19/16"	150mm 5 9/16"	6mm 11/16"

Part No.	Barcode	Type	Pieces	Box	Box	Box	Box	Box	Box	Box	Box	Box	Box	Box	Box
312P300	8024648009845	⊙	-	-	-	-	-	-	-	-	300	65x45xh 45 cm	25 9/16"x17 3/4"xh 17 3/4"	27,4 Kg	60.4 lbs



EXPANSION JOINTS AND PROFILES

MADE IN ITALY

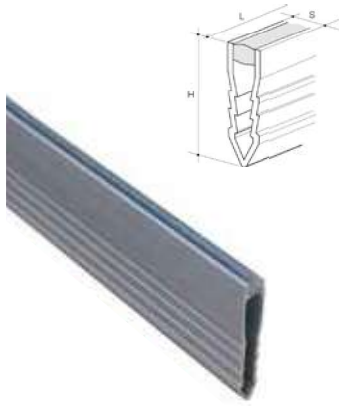

401

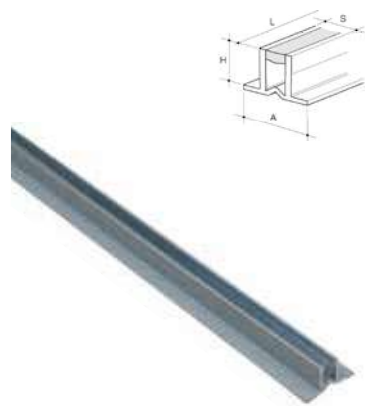

400



404/405/406

PACKAGE



CARTON BOX

EXPANSION JOINTS FOR THIN-SET ADHESIVE

Part No.	Barcode	Box Qty	Description	COLOR		S	H	Profile	Total Qty	Box Dimensions	Weight
				External	Internal						
400 7X8G	8024648001993	40	Raiflex joint	grey	clear	8 mm 5/16"	7 mm 9/32"	250 cm 8' 2 1/2"	100 m 328'	254x12xh 9 cm 100"x4 3/4"xh 3 1/2"	8,3 Kg 18.3 lbs
400 9X8G	8024648002006	40	Raiflex joint	grey	clear	8 mm 5/16"	9 mm 23/64"	250 cm 8' 2 1/2"	100 m 328'	254x12xh 9 cm 100"x4 3/4"xh 3 1/2"	11,5 Kg 25.3 lbs
400 11X8G	8024648002013	40	Raiflex joint	grey	clear	8 mm 5/16"	11 mm 7/16"	250 cm 8' 2 1/2"	100 m 328'	254x12xh 9 cm 100"x4 3/4"xh 3 1/2"	14,7 Kg 32.4 lbs
400 13X8G	8024648002020	40	Raiflex joint	grey	clear	8 mm 5/16"	13 mm 33/64"	250 cm 8' 2 1/2"	100 m 328'	254x12xh 9 cm 100"x4 3/4"xh 3 1/2"	17,9 Kg 39.4 lbs
400 15X8G	8024648002037	40	Raiflex joint	grey	clear	8 mm 5/16"	15 mm 19/32"	250 cm 8' 2 1/2"	100 m 328'	254x12xh 9 cm 100"x4 3/4"xh 3 1/2"	21,1 Kg 46.5 lbs
400 20X8GG	8024648095732	40	Raiflex joint	light grey	light grey	8 mm 5/16"	19 mm 3/4"	250 cm 8' 2 1/2"	100 m 328'	254x16xh 9 cm 100"x6 1/4"xh 3 1/2"	16 Kg 35.3 lbs

EXPANSION JOINTS FOR MORTAR / MUD

Part No.	Barcode	Box Qty	Description	COLOR		S	H	Profile	Total Qty	Box Dimensions	Weight
				External	Internal						
401 23X8G	8024648002112	40	Raiflex joint	grey	clear	8 mm 5/16"	25 mm 31/32"	250 cm 8' 2 1/2"	100 m 328'	254x12xh 9 cm 100"x4 3/4"xh 3 1/2"	12,9 Kg 28.4 lbs
401 35X8G	8024648002105	40	Raiflex joint	grey	clear	8 mm 5/16"	35 mm 1 3/8"	250 cm 8' 2 1/2"	100 m 328'	254x16xh 9 cm 100"x6 1/4"xh 3 1/2"	22,5 Kg 49.6 lbs

PVC TRANSITION PROFILES

Part No.	Barcode	Box Qty	Description	COLORE	H	Profile	Total Qty	Box Dimensions	Weight
404TRIM6B	8024648002303	100	Jolly PVC	white	6 mm	250 cm	250 m	254x13xh 9 cm	13,3 Kg
404TRIM6G	8024648002310	100	Jolly PVC	grey	15/64"	250 cm	820' 2 1/2"	100"x5 1/16"xh 3 1/2"	29.3 lbs
405TRIM8B	8024648002334	80	Jolly PVC	white	8 mm	250 cm	200 m	254x13xh 9 cm	13,9 Kg
405TRIM8G	8024648002341	80	Jolly PVC	grey	5/16"	250 cm	656' 2"	100"x5 1/16"xh 3 1/2"	30.6 lbs
406TRIM10B	8024648002365	50	Jolly PVC	white	10 mm	250 cm	125 m	254x13xh 9 cm	10,8 Kg
406TRIM10G	8024648002372	50	Jolly PVC	grey	13/32"	250 cm	410' 1 1/4"	100"x5 1/16"xh 3 1/2"	23.8 lbs

SPACERS, EXPANSION JOINTS AND PROFILES